



CLAVIS Deutschland GmbH
Schillerstraße 47-51
34117 Kassel

Telefon: +49 (0)561 988 499-0
Fax: +49 (0)561 988 499-99
E-Mail: info@tresore.eu
Internet: www.tresore.eu
www.tresorschloss.de



KABA®

Combi B 30 with metal input unit

Operating Instructions

EN

Table of contents

16	Important notes	28
17	Glossary of abbreviations and terms	29
18	The icons used in the instructions	30
19	Lock system: Input unit and lock	31
19.1	Operating elements of the input unit	31
19.2	Lock housing and interfaces	31
20	Overview of authorizations	32
21	Overview of the programming commands	32
22	Overview of the possible signals	33
23	Start-up of the lock	34
23.1	Opening with factory code	34
23.2	Activating master	34
24	Programming functions for the master	34
24.1	Changing master code (P)	35
24.2	Programming functions for further codes (P3-P6)	35
24.2.1	Activating user codes or courier codes (P3)	35
24.2.2	Blocking the user codes or courier codes (P4)	36
24.2.3	Releasing the user codes or courier codes (P4)	36
24.2.4	Deleting the user codes or courier codes (P5)	36
24.2.5	Code status query (P6)	37
24.3	Programming time delay and confirmation window (P2)	37
24.3.1	Activating time delay and confirmation window (P2)	37
24.3.2	Deactivating time delay and confirmation window (P2)	37
24.4	Programming the dual code (P7)	38
24.4.1	Activating the dual code (P7)	38
24.4.2	Deactivating dual code (P7)	38
24.5	Programming silent alarm (P8)	39
24.5.1	Activating the silent alarm (P8)	39
24.5.2	Deactivating silent alarm (P8)	39
24.6	Acknowledging tamper switch message (P9)	39
25	Lock functions for all users	40
25.1	Opening the lock without programmed TD/CW	40
25.2	Opening the lock with programmed TD/CW	40
25.3	Opening with dual code	41
25.4	Opening with silent alarm	41
25.5	Lockout period (3 or more incorrect code inputs)	42
25.6	Closing the lock	42
25.7	Changing codes (P)	42
25.8	Opening with activated additional functions	43
26	Key functions	43
26.1	Key opening	43
26.2	Closing using the key	44

26.3	Changing master code using the key (P)	44
26.4	Resetting the lock (P0).....	44
26.5	Reconfiguration of the lock after opening by means of the key using software	45
27	Further special functions	45
27.1	Connection to the PC software	45
27.2	Additional functions via the signal input	45
27.3	Additional functions via the signal outputs	45
28	Power supply	45
28.1	Low battery	46
28.2	Battery replacement.....	46
28.3	Permanent power supply.....	47
29	Service	47
30	Notes	48

List of tables

Table 1: Icons	30
Table 2: Authorizations	32
Table 3: Programming commands.....	32
Table 4: Messages from the lock, terms see chapter 2, icons see chapter	33
Table 5: Opening with factory code	34
Table 6: Activating master	34
Table 7: Changing master code	35
Table 8: Activating code	35
Table 9: Blocking the code.....	36
Table 10: Releasing code	36
Table 11: Deleting code	36
Table 12: Requesting code status	37
Table 13: Code status messages	37
Table 14: Programming time delay and confirmation window.....	37
Table 15: Deleting time delay and confirmation window	38
Table 16: Activating dual code.....	38
Table 17: Deactivating dual code.....	38
Table 18: Activating silent alarm	39
Table 19: Deactivating silent alarm.....	39
Table 20: Acknowledging the tamper switch message	40
Table 21: Opening with master or user code	40
Table 22: Opening with programmed TD/CW	40
Table 23: Opening with dual code	41
Table 24: Alarm code examples	41
Table 25: Opening with alarm code	42
Table 26: Changing code.....	42
Table 27: Changing master code using the key.....	44
Table 28: Resetting the lock	45

List of figures

Figure 1: Input unit	31
Figure 2: Mini-USB socket	31
Figure 3: Lock housing	31
Figure 4: Connections at the lock housing.....	31
Figure 5: Opening with the key	43
Figure 6: Battery replacement.....	46
Figure 7: Label with the production data in the input unit.....	47
Figure 8: Information on the label	47

16 Important notes



Before the start-up of the lock read these operating instructions carefully and observe the following notes:

- **The enclosed inspection key allows full access to the lock and its configurations even in case of code loss. Thus, it is at the highest hierarchy level of the lock. Therefore, it must be stored in a safe place, but not in the secure storage unit.**
- For security reasons programming and battery replacement should always be performed and then tested with the secure storage unit open.
- Every correct key stroke recognized by the lock is confirmed by an acoustic signal.
- You have max. 10 sec. for each individual key stroke. If no key is pressed during these 10 seconds, the electronics shuts down automatically. Uncompleted operations must be restarted after that. The only exceptions to this are the code status query and the programming mode with 30 seconds response time until automatic shutdown.
- Code inputs resp. all further functions (e.g. programming operations) can be cancelled until the last key stroke by pressing the **[P]** key twice.
- Do not use for your code personal or similar known data which are easy to find out.
- If the set code(s) is(are) not available, the lock can be opened or reset using the enclosed inspection key.
- The lock is designed for use in the temperature range from +10° C to +50° C and with humidity of 30% to 80% (non-condensing).
- The lock must never be greased with or contact other lubricants or aggressive liquids, it must be cleaned only with a moist cloth only (no aggressive cleaning agents).
- Never open the lock housing. Dismount the fitting only for battery replacement and perform it strictly according to the specifications of these operating instructions. Avoid touching electronic components. Otherwise, you endanger the functions of the lock and loose the right for the warranty claims.
- During start-up the serial number of the input unit is saved in the audit memory of the lock. Replacement of the input unit is also registered by means of an entry in the audit memory of the lock.
- For every description of operation or programming processes hereafter it is assumed that the lock and the input unit are in the basic state. Basic state means that the lock is closed (the bolt lock is extended) and the lock electronics is switched off. If you are not sure, whether the lock is closed, check if the rotary knob can be turned counterclockwise. To ensure that the lock is not in a running programming process, you can press the **[P]** key twice to cancel it.
- **Upon delivery the lock is set by Kaba Mauer GmbH to the factory code "1". For security reasons activate the master code with your individual code immediately in order to deactivate the factory code. The factory code is meant only for lock mounting, it is not suitable for further permanent use.**
- **Furthermore, the lock has the option for partial or full start-up by the safe manufacturer or distributor:**
For a partial start-up basic configurations are loaded to the lock without activation of the master code. So, the lock still opens with "1". All configurations performed previously using software are immediately valid only after activation of the master code (start-up according to 8.2).
For full start-up the lock has already been provided with a master code and further settings if necessary. In both cases the set basic configuration is communicated separately by the safe manufacturer or distributor. If a full start-up has been performed and, thus, a master code preset as delivery code, the safe manufacturer or distributor can save it additionally in the following hatched text box.
All pre-configured codes have to be changed by the end user immediately after start-up.

The master code set by the distributor resp. safe manufacturer (delivery code):

0 0 _ _ _ _ _

Note for the end user:

Change all delivery codes immediately!

If further codes have been pre-assigned, see separate information of the safe distributor resp. manufacturer.

Stamp of the safe manufacturer/distributor

17 Glossary of abbreviations and terms

- Code: Numerical sequence of 8 digits for identification of the operator consisting of ID and PIN.
- ID: fixed 2-digit operator number.
- PIN: freely selectable 6-digit combination (Notice, do not use personal data such as for example date of birth).
- Operator: the master, user and courier are operators of the lock – each operator of the lock has an individual ID (00, 01..30; 95) assigned.
- Master code: ID 00; the highest code of the code hierarchy, can open the lock, change its own code, it is required for almost all programming functions of the lock. Can also perform programming functions independently in the double-code mode.
- User code: ID 01 to 30, can open the lock and change its own code.
- Courier code: ID 95, can open the lock without waiting for a time delay which might be programmed and change its own code.
- Factory code: has no ID, can open the lock during mounting at the factory.
- TD: adjustable time which has to pass before the lock can be opened.
- CW: Confirmation window: adjustable time which starts after the time delay; The lock can be opened during the confirmation window.
- Lockout period: After entering the code 3 times incorrectly the lockout period is activated, no inputs are possible at the lock during the lockout period.
- Dual code: Two different valid codes are required to open the lock.
- Silent alarm: If the lock is connected to an external alarm system (intruder detection system) and this function is activated at the lock, a silent duress alarm can be triggered (not perceivable for the intruder).
- EMA: Intruder detection system: external alarm system for evaluation / forwarding of the duress alarm or secured permanent power supply (not included in the scope of delivery).
- Low battery: indicates that the batteries are low and must be replaced as soon as possible in order to ensure secure function of the lock.
- AHK: Tamper switch: A contact in the input unit which detects whether the input unit has been opened (e.g. for battery replacement).
- Audit: All relevant events (opening, closing, programming etc.) are saved in the audit memory (approx. 200 events) of the lock. If the memory is full, the oldest entry is overwritten automatically. The audit can be read out using software.
- Reset: Reset of the lock to the delivery state, only the master code and audit remain unchanged.
- Inspection key: The inspection key can open the lock any time mechanically independent of the electronics. Opening by means of the key does not have any TD or lockout period. The inspection key can also be used to assign a new master code and reset the complete lock. Reconfiguration of the lock can be implemented using the inspection key and software without knowing or changing the master code. Therefore, the inspection key is positioned higher in the code structure than the master code and must be stored in a safe place (not in a secure storage unit).

Kundendienst



CLAVIS Deutschland GmbH
Schillerstraße 47-51
34117 Kassel

Telefon: +49 (0)561 988 499-0
Fax: +49 (0)561 988 499-99
E-Mail: info@tresore.eu
Internet: www.tresore.eu
www.tresorschloss.de

18 The icons used in the instructions















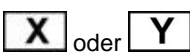

Icon	Meaning
	Warning
	Important
	Note
	Icon for the 2-digit code ID (also refer to chapter 2)
	Icon for individual number keys for the code input
	Action performed
	Action not performed
	Rotate the actuating knob through 90° clockwise.
	Rotate the actuating knob through 90° counterclockwise.
	Short signal LED green
	Continuous signal LED green
	LED green off
	Short signal LED red
	Continuous signal LED red
	LED red off
	Buzzer signal

Table 29: Icons

19 Lock system: Input unit and lock

The entire lock system consists of a visible input unit and the lock installed in the secure storage unit. All programmed codes and functions are saved only in the lock and, thus, in the secured area.

19.1 Operating elements of the input unit

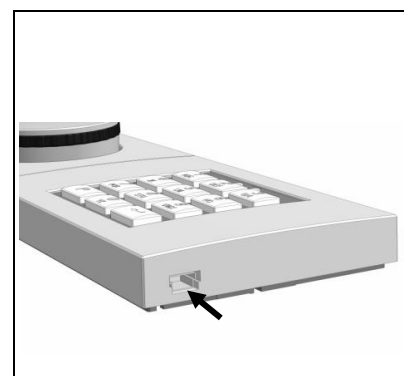
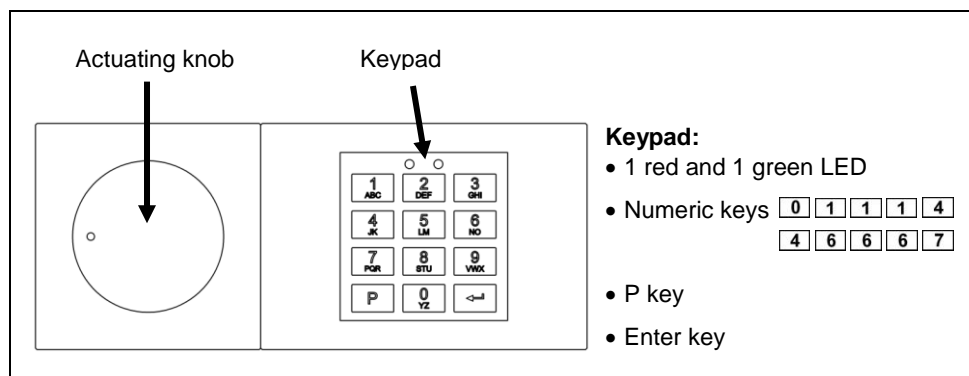

Figure 9: Input unit

Figure 10: Mini-USB socket
 Special interface, only in connection with original Kaba Mauer CB30
 Use PC cable!

19.2 Lock housing and interfaces

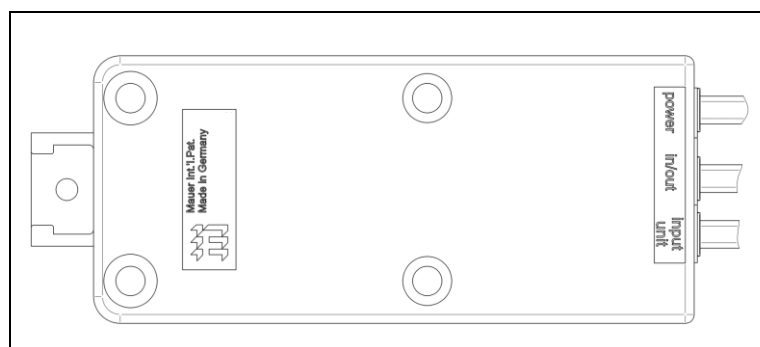

Figure 11: Lock housing

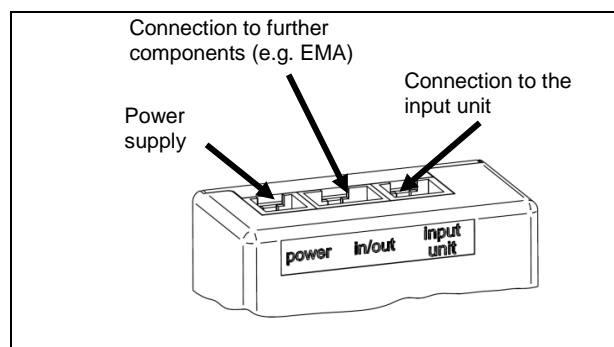

Figure 12: Connections at the lock housing

20 Overview of authorizations

The authorizations of individual operators are as follows:

Operator ID	Code designation	Authorization
-	Inspection key	<ul style="list-style-type: none"> - Opening without TD/CW and without lockout period - Assigning of a new master code - Resetting the lock - Changing the lock configurations using software without knowing the master code or changing it.
00	Master code	<ul style="list-style-type: none"> - Opening, if necessary, with silent alarm - Changing of the own code - Activating, blocking, releasing, deleting user and courier, with activated dual code as well - Activating / deactivating dual code - Programming / deleting TD/CW - Neutralising the tamper switch - Reading out audit - Activating, deactivating silent alarm - Access via PC software
01..30	User codes	<ul style="list-style-type: none"> - Opening, if necessary, with silent alarm - Changing of the own code
95	Courier code	<ul style="list-style-type: none"> - Opening without TD/CW, if necessary, with silent alarm - Changing of the own code
-	Factory code	<ul style="list-style-type: none"> - Opening - Valid only until the real start-up of the lock, NOT A REAL CODE, not suitable for permanent use

Table 30: Authorizations

21 Overview of the programming commands

Action	Command	Authorization
Changing own code	P	each
Reading out audit	P1	Master
Activating + deactivating TD/CW	P2	
Activating user	P3	
Blocking + releasing user	P4	
Deleting user	P5	
Code status query	P6	
Activating + deactivating dual code	P7	
Activating + deactivating silent alarm	P8	
Acknowledging the tamper switch message	P9	
Resetting the lock	P0	
Reassignment of the master code	P	

Table 31: Programming commands

22 Overview of the possible signals

Event	When	Signal
Pressing the key (e.g. code input)	With every key stroke	1 x
<ul style="list-style-type: none"> Code valid (code-correct message) Correct input 	After pressing Enter	2 x and 2 x
<ul style="list-style-type: none"> Error message (e.g. code invalid) Recurring input (e.g. code confirmation) not matching Cancellation (manual cancellation with or time-controlled cancellation if there is no input) 	After pressing Enter	3 x and 3 x
Tamper switch has been activated	3 x after pressing Enter	1 x and 1 x , then 1 x and 1 x
Lockout period	Permanently after pressing Enter	1 x , then 0.5 s break
Dual code; input of the second code is expected	Permanently after pressing Enter	1 x , then 2 s break
TD	Permanently after pressing Enter	1 x , then 5 s break
CW	Permanently after pressing Enter	1 x and 1 x , then 5 s break
Undervoltage	After pressing Enter	10 x
Programming mode	Permanently after pressing Enter	1 x and
Remote disable activated, no opening possible	With every key stroke	1 x
Hardware error. Contact the Service.	After pressing Enter	3 s and 3 s
No connection to lock! Check cable connection (plug at the lock in „input unit“?); Top part of input unit not completely end positioned?	After fitting the top part of the input unit	permanent
Code status messages		
Code active	After pressing Enter	1 x and 1 x
Code active but blocked		1 x , 1 x and 1 x
Code deleted or inactive		1 x and 1 x

Table 32: Messages from the lock, terms see chapter 2, icons see chapter

23 Start-up of the lock

The lock installation as well as cabling and the first battery installation are described in the installation manual.

As long as the lock system has not been put into operation, it can be opened using the factory code.

The factory code is intended for lock mounting at the factory and not for further permanent use.

For correct start-up of the lock the master code must be activated correctly according to chapter 8.2, this makes the factory code invalid.



If the start-up or partial start-up has already been performed by the safe manufacturer or distributor, the corresponding information is specified in its manuals/notes. Furthermore, the safe manufacturer or distributor can document the set master code in this manual. For this information refer to the field highlighted in gray in chapter 1 page 4, "Master code set by the distributor resp. safe manufacturer".

23.1 Opening with factory code

Description	✓		✗	
1. Press 1 and	2x	2x	3x	3x
2. Turn the actuating knob within 4 seconds through 90° clockwise to the stop . Then open the storage unit.				

Table 33: Opening with factory code



As long as the factory code is used for opening (master is not activated yet), there is no lockout period for incorrect code inputs according to chapter 10.5 and no tamper switch signal message according to either.

23.2 Activating master

Now activate the master **with the storage unit open** (to have every time access to the storage unit and the lock).

Description	✓		✗	
1. Press P and		2x	3x	3x
2. Enter the new master code 0 0 X X X X X X and (00 = ID, X = freely selected 6-digit combination [0..9])		2x	3x	3x
3. Confirm the new master code with 0 0 X X X X X X and	2x	2x	3x	3x

Table 34: Activating master

Then check the performed programming with the storage unit still open. To do so, proceed according to chapter 10.1.



If the Incorrect code signal is output, the procedure must be repeated since both codes do not match or the ID (here 00) has been entered incorrectly.

Changing of the master code can be canceled any time by pressing **P** twice. Alternatively, the process can be canceled if no input is performed within 30 seconds.

24 Programming functions for the master

All programming functions described here require the master code for authorisation.



For security reasons, programming and testing of programming should always be performed with the secure storage unit open (to have every time access to the storage unit and the lock). Programming can be performed any time individually and without waiting times (exception - lockout periods), even if the dual code and/or TD/CW are activated. All programming processes can be canceled by pressing **P** twice. Alternatively, the input can be canceled if no input is performed within 30 seconds.

24.1 Changing master code (P)

After modification of the master code the previous master code is no longer valid. The function of the new master code must be checked by opening the lock with the secure storage unit open (see chapter 10.1)!

Description	✓		✗	
1. Press [P] and enter the current master code [0][0][X][X][X][X][X][X] and [↵] (00 = ID, X = previously programmed 6-digit combination)		2x	3x	3x
2. Enter the new master code [0][0][Y][Y][Y][Y][Y][Y] and [↵] (00 = ID, Y = new 6-digit combination)		2x	3x	3x
3. Confirm the new master code with [0][0][Y][Y][Y][Y][Y][Y] and [↵]		2x	3x	3x

Table 35: Changing master code

The entire procedure has to be repeated in case of the following errors:
 If Incorrect code signal is displayed according to 1. after the input of the current code, the code has been entered incorrectly.
 If the Incorrect code signal is displayed after the second attempt to enter the new code as shown in 3., then the two codes entered in 2. resp. 3 do not match.

24.2 Programming functions for further codes (P3-P6)

This section describes the basic programming procedures for further codes (user or courier codes). This includes activation, deletion, blocking and releasing of these codes. The basic code structure is given in chapter 5 authorizations. Furthermore, this chapter describes the code status query used by the master code to request the status of individual codes directly from the lock.

For correct use of the lock the master code must be activated (see chapter 8.2).

24.2.1 Activating user codes or courier codes (P3)

Code can be used only after it has been activated. When activating a new operator, it is useful if the new code (starting from item 3 of the following description) is entered directly by the respective operator on site. If the new code is not entered by the operator directly but is specified by the master, it must be replaced by the real personal code in the course of code changing as soon as possible (see chapter 10.7).

Description	✓		✗	
1. Press [P] and enter the valid master code [0][0][X][X][X][X][X][X] and [↵] (00 = ID, X = valid 6-digit combination for the master)		2x	3x	3x
2. Press [P][3] and [↵]		2x	3x	3x
3. Enter the new code [I][D][X][X][X][X][X][X] and [↵] (ID = 01 to 30 for user resp. 95 for courier, X = freely selectable 6-digit combination [0..9])		2x	3x	3x
4. Confirm the new code with [I][D][X][X][X][X][X][X] and [↵]		2x	3x	3x

Table 36: Activating code

After the activation the new saved code is valid and can be used. The new code has to be tested by opening the lock (see chapter 10.1)!

If both entered codes do not match, the incorrect code signal is output after the second code input. If the Incorrect code signal is displayed after the first code input, the code is already active or not available.

24.2.2 Blocking the user codes or courier codes (P4)

After blocking, the code cannot be used anymore until it is released again (see chapter 9.2.3) In contrast to deletion, after blocking the code remains unchanged in the lock and can be used again after releasing.

Description	✓			✗	
1. Press P and enter the valid master code 0 0 X X X X X X X and ↵ (00 = ID, X = valid 6-digit combination for the master)			2x	3x	3x
2. Press P 4 and ↵			2x	3x	3x
3. Enter the ID to be blocked I D and ↵ (ID = 01 to 30 for user resp. 95 for courier)		2x	2x	3x	3x

Table 37: Blocking the code



If the Incorrect code signal is displayed after step 3, then either the ID has not been activated or it is not available. If only the red LED is missing during the acknowledgment signal, the code has not been blocked but released, because it had been blocked before that. Perform the entire procedure again to block the code again. Blocking of the master code is not possible.

24.2.3 Releasing the user codes or courier codes (P4)

After releasing of the code blocked previously according to 9.2.2, it can be used again.

Description	✓		✗	
1. Press P and enter the valid master code 0 0 X X X X X X X and ↵ (00 = ID, X = valid 6-digit combination for the master)		2x	3x	3x
2. Press P 4 and ↵		2x	3x	3x
3. Enter the ID to be released I D and ↵ (ID = 01 to 30 for user resp. 95 for courier)	2x	2x	3x	3x

Table 38: Releasing code



If the Incorrect code signal is displayed after step 3, then either the ID has not been activated or it is not available. If the red LED is displayed additionally to the normal acknowledgment signal, the code has not been released but blocked, because it had been released before that. Perform the entire procedure again to release the code again.

24.2.4 Deleting the user codes or courier codes (P5)

In contrast to blocking (see chapter 9.2.3) the code is irretrievably lost after deletion. To use it again, it has to be activated again (see chapter 9.2.1). Blocked codes can be deleted without previous releasing.

Description	✓		✗	
1. Press P and enter the valid master code 0 0 X X X X X X X and ↵ (00 = ID, X = valid 6-digit combination for the master)		2x	3x	3x
2. Press P 5 and ↵		2x	3x	3x
3. Enter the ID to be deleted I D and ↵ (ID = 01 to 30 for user resp. 95 for courier)	2x	2x	3x	3x

Table 39: Deleting code



If the Incorrect code signal is displayed after step 3, then either the ID has not been activated or it is not available. Deletion of the master code is not possible. However, the master code can be reassigned using the key (see chapter 11.3).

24.2.5 Code status query (P6)

The status of any code (active, blocked or inactive resp. deleted) can be requested in this query program. Neither the codes nor their statuses are changed by this operation. The statuses of any number of IDs can be requested successively. Different code statuses are given in Tabelle 13.

Description	✓			✗	
1. Press P and enter the valid master code 0 0 X X X X X X X and ↵ (00 = ID, X = valid 6-digit combination for the master)			2x	3x	3x
2. Press P 6 and ↵	2x		2x	3x	3x
3. Enter all the ID(s) to be requested I D successively and ↵ correspondingly One code status message is generated for each ID according to				3x	3x
4. Quit the query mode by pressing P P . Alternatively, wait for 30 seconds		3x	3x		

Table 40: Requesting code status

Code status message			
(active)	1x		1x
(active but blocked)	1x	1x	1x
(deleted/inactive)		1x	1x

Table 41: Code status messages

24.3 Programming time delay and confirmation window (P2)

Time delay (TD) is the time period which has to elapse before the lock can be opened. The confirmation window (CW) denotes the time window during which the lock can be opened as soon as the TD has elapsed. This program is used to set or delete the TD (01 to 99 minutes) and the CW (01 to 19 minutes). The set times apply to all users and for the master but not for the courier.

24.3.1 Activating time delay and confirmation window (P2)

To program time delay (TD) and confirmation window (CW) proceed as follows:

Description	✓		✗	
1. Press P and enter the valid master code 0 0 X X X X X X X and ↵ (00 = ID, X = valid 6-digit combination for the master)			2x	3x
2. Press P 2 and ↵		2x	3x	3x
3. Enter the time delay X X and the confirmation window Y Y and ↵ (XX = 01 to 99, YY= 01 to 19, specifications in minutes respectively)	2x	2x	3x	3x

Table 42: Programming time delay and confirmation window

If the Incorrect code signal is displayed after step 3, the specified times are outside of the maximum permitted range. The Incorrect code signal is also displayed if 00 is specified either only for the TD or for the CW. Both inputs are not permitted.

24.3.2 Deactivating time delay and confirmation window (P2)

To deactivate time delay (TD) and confirmation window (CW), proceed as described in chapter 9.3.1; while doing so, enter "00" for the 2-digit TD as well as for the 2-digit CW respectively. After that all operators can open the lock without delay.

Description	✓		✗	
1. Press [P] and enter the valid master code 0 0 X X X X X X and [↵] (00 = ID, X = valid 6-digit combination for the master)		2x	3x	3x
2. Press [P 2] and [↵]		2x	3x	3x
3. Enter 0 0 0 0 and [↵]	2x	2x	3x	3x

Table 43: Deleting time delay and confirmation window

24.4 Programming the dual code (P7)

The dual code function allows to set the lock in such a way that two optional but different codes (different IDs) are required to open the lock. The dual code includes all operators (master, user and courier). This programming command is used to activate or deactivate the dual code.

24.4.1 Activating the dual code (P7)

In order to activate the dual code proceed as follows:

Description	✓		✗	
1. Press [P] and enter the valid master code 0 0 X X X X X X and [↵] (00 = ID, X = valid 6-digit combination for the master)		2x	3x	3x
2. Press [P 7] and [↵]	2x	2x	3x	3x

Table 44: Activating dual code

The lock can be opened only as described in 10.3.



To activate the dual code, at least two operators with valid codes must be created. Otherwise, an error message is displayed during activation of the dual code.

The dual code must be deactivated in order to be able to activate it.

If the red LED is displayed additionally to the normal acknowledgment signal, the dual code has been activated previously and is deactivated now. To activate it again, repeat the entire procedure.

24.4.2 Deactivating dual code (P7)

In order to deactivate the dual code proceed as follows:

Description	✓			✗	
1. Press [P] and enter the valid master code 0 0 X X X X X X and [↵] (00 = ID, X = valid 6-digit combination for the master)			2x	3x	3x
2. Press [P 7] and [↵]		2x	2x	3x	3x

Table 45: Deactivating dual code



The dual code must be activated in order to be able to deactivate it.

If the red LED is missing during the acknowledgment signal, the dual code has been deactivated previously and is activated now. To deactivate it again, repeat the entire procedure.

24.5 Programming silent alarm (P8)

A silent alarm is triggered by a special code input. The message in question is an alarm message which initiates the lock using an alarm output, the lock can still be opened during this. However, to forward the silent alarm, the alarm output must be connected to the intruder detection system (not included in the scope of delivery) (for further details refer to the installation manual or consult an installer of intruder detection systems). This programming command is used to activate or deactivate the silent alarm. To open the lock using the alarm code proceed as described in 10.4.



If the silent alarm is deactivated, the alarm codes are acknowledged as incorrect codes and the lock does not open.

24.5.1 Activating the silent alarm (P8)

To activate the silent alarm proceed as follows: After that the silent alarm is activated and the alarm codes can be used.

Description	✓		x	
1. Press [P] and enter the valid master code 0 0 X X X X X X and [↵] (00 = ID, X = valid 6-digit combination for the master)		2x	3x	3x
2. Press [P] [8] and [↵]		2x	3x	3x

Table 46: Activating silent alarm



The silent alarm must be deactivated in order to be able to activate it. If the red LED is displayed additionally to the normal acknowledgment signal, the silent alarm has been activated previously and is deactivated now. To activate it again, repeat the entire procedure.

24.5.2 Deactivating silent alarm (P8)

To deactivate the silent alarm proceed as follows: After that the silent alarm is deactivated, the alarm codes are acknowledged as incorrect codes and the lock can no longer be opened with an alarm code.

Description	✓			x	
1. Press [P] and enter the valid master code 0 0 X X X X X X and [↵] (00 = ID, X = valid 6-digit combination for the master)			2x	3x	3x
2. Press [P] [8] and [↵]		2x	2x	3x	3x

Table 47: Deactivating silent alarm



The silent alarm must be activated in order to be able to deactivate it. If the red LED is missing during the acknowledgment signal, the silent alarm has been deactivated previously and is activated now. To deactivate it again, repeat the entire procedure.

24.6 Acknowledging tamper switch message (P9)

The lock is equipped with a tamper switch (AHK), which is tripped when opening the input unit (e.g. to replace the battery or after a manipulation); after that it is displayed with the manipulation signal for each opening/operation until the acknowledgment (3x und 3x im Wechsel + 6x).

This programming command acknowledges the tamper switch message. This procedure is saved in the event memory/audit of the lock like all other procedures.



If the signal mentioned above is displayed even if no battery replacement has been performed, the input unit might have been manipulated, for example to spy out the code. So, before you acknowledge this message, make sure that no manipulation has been performed at the input unit. If you are not sure, whether there has been a manipulation or not, consult an authorized service!

To acknowledge the tamper switch message and, thus, switch off the manipulation indication, proceed as follows:

Description	✓		✗	
1. Press [P] and enter the valid master code [0][0][X][X][X][X][X][X] and [↵] (00 = ID, X = valid 6-digit combination for the master)		2x	3x	3x
2. Press [P][9] and [↵]		2x	3x	3x

Table 48: Acknowledging the tamper switch message

25 Lock functions for all users

Every key stroke is confirmed by a key tone (). The input can be canceled any time by pressing **[P]** twice. Alternatively, the input can be canceled if no input is performed within 10 seconds.

After three incorrect code inputs the lock switches to lockout period. For details on the lockout period refer to chapter 10.5.

If the undervoltage signal (10x) is displayed after the code entry, then the battery capacity is low and the batteries must be replaced as soon as possible. For further details refer to chapter 13.

If the tamper switch signal (3x and 3x alternately + 6x) is displayed after the code entry, the input unit has been opened. To find out more read chapter 9.6.

The lock has a function which hinders spying out of codes by means of user observation during code input: During all opening procedures the operator can add as many further digits as necessary before completing the input by pressing **[8]**. All inputs starting from the 9th position will be ignored. Notice: This function supports only the code input for opening and is not available for the programming procedures.

Opening with activated additional functions: The lock offers an option to execute further additional functions triggered by external signals. For further details refer to chapter 10.8.

25.1 Opening the lock without programmed TD/CW

Description	✓		✗	
1. Enter a valid opening code [I][D][X][X][X][X][X][X] and [↵] (ID = 00 to 30 resp. 95, X = programmed 6-digit combination for the corresp. ID number)	2x	2x	3x	3x
2. Turn the actuating knob within 4 seconds through 90° clockwise to the stop .				

Table 49: Opening with master or user code

If the Incorrect code signal is output after the code input, the entry must be repeated completely. After 3 incorrect inputs the lock switches to the lockout period (see chapter 10.5)

25.2 Opening the lock with programmed TD/CW

Description	✓		✗	
1. Enter a valid opening code [I][D][X][X][X][X][X][X] and [↵] (ID = 00 to 30 or 95, X = programmed 6-digit combination for the corresp. ID number) If you have entered a courier code here, proceed directly with step 4.	2x	2x	3x	3x
2. If you have not entered any courier code (ID 95), the signal for the running time delay is displayed now (1x ; 5 s break). Wait until it is completely over.				
3. The confirmation window starts after the time delay (1x + 1x ; 5 s break) Now enter a valid opening code [I][D][X][X][X][X][X][X] and [↵] again (ID = 00 to 30, X = programmed 6-digit combination for the corresp. ID number)	2x	2x	3x	3x
4. Turn the actuating knob within 4 seconds through 90° clockwise to the stop .				

Table 50: Opening with programmed TD/CW



The running time delay can be canceled any time by pressing **P** twice. If the Incorrect code signal is output after the code input, the entry must be repeated completely. After 3 incorrect inputs the lock switches to the lockout period (see chapter 10.5).

Courier code:

After entering the courier code (ID 95) the lock can be opened immediately if the programmed TD (time delay) is avoided in a certain manner (steps 2 and 3 are omitted).

Dual code mode:

In the dual code mode the entire dual code must be entered in step 3 according to 10.3. The TD is, thus, started only by the input of an individual code.

Avoiding the TD/CW with the courier code in the dual code mode:

To enable this, the courier code must be the first entered code in the dual code mode. Then the second code (not the courier code) can be entered and after that the lock can be opened.

Inspection key:

The TD can be avoided if the inspection key is used, but it cannot be deleted (see chapter 11.1).

25.3 Opening with dual code

Description	✓		✗	
1. Enter the first valid opening code I D X X X X X X and ↵ (ID = 00 to 30 or 95, X = programmed 6-digit combination for the corresp. ID number)	2x	2x	3x	3x
2. Now the signal for the input of the second is displayed (1x ; 2 s break)				
3. Enter another valid opening code I D Y Y Y Y Y Y and ↵ (ID = 00 to 30 or 95, however, other than in step 1, Y = programmed 6-digit combination for the corr. ID number)	2x	2x	3x	3x
4. Turn the actuating knob within 4 seconds through 90° clockwise to the stop .				

Table 51: Opening with dual code



The operator IDs of both codes must not match. The order of the code input is irrelevant, unless it is necessary to open the lock while avoiding the TD/CW, then refer to 10.2. If the Incorrect code signal is output after the first code input, the entry must be repeated completely. If the Incorrect code signal is displayed after the second code input, the second entered code is incorrect or identical to the first input (identical IDs). In both cases the input must be repeated completely. After a total of 3 incorrect inputs the lock switches to the lockout period (see chapter 10.5). It is irrelevant here, whether the faulty input was in the first or the second code. Even if the faulty inputs occur in the first or second code alternately, after 3 incorrect inputs the lock switches to the lockout period.

25.4 Opening with silent alarm

If there is a threatening situation, the lock can be opened with simultaneous generation of a silent alarm, provided the silent alarm has been activated according to chapter 9.5 and the lock is connected to an intruder detection system (not included in the scope of delivery). A special alarm code derived from a valid code must be entered for this purpose (if the dual code is activated, one of the codes is sufficient). If an alarm code is entered, the lock opens externally as usual but a silent alarm is initiated additionally without further visible/audible feedback.

The alarm code consists of a valid code, the last position/digit of this code is increased or decreased by one digit (+1 or -1; see examples). If the last code digit is 0 or 9, then the digit next to the last in the alarm code is **not** changed (see example 2). If an time delay has been programmed, this time has to elapse still in spite of the alarm code input.



If the silent alarm is deactivated, the alarm codes are acknowledged as incorrect codes and the lock cannot be opened resp. the TD is not activated.

Examples:

Normal code	00123459	Normal code	00123456
Alarm code -1	00123458	Alarm code -1	00123455
Alarm code +1	00123450	Alarm code +1	00123457

Table 52: Alarm code examples

Opening process:

Description	✓		✗	
1. Enter a modified valid opening code as an alarm code <input type="text" value="I"/> <input type="text" value="D"/> <input type="text" value="X"/> <input type="text" value="X"/> <input type="text" value="X"/> <input type="text" value="X"/> <input type="text" value="X"/> <input type="text" value="X"/> <input type="text" value="Y"/> and <input type="text" value="↵"/> (ID = 00 to 30 or 95, X = the first 5 positions of the programmed 6-digit combination for the corr. ID number, Y = increased by 1 or decreased at the 6th position of the combination mentioned above)	2x	2x	3x	3x
2. Turn the actuating knob within 4 seconds through 90° clockwise to the stop .				

Table 53: Opening with alarm code



If the Incorrect code signal is output after the code input, the entry must be repeated completely. After 3 incorrect inputs the lock switches to lockout period in this case as well (see chapter 10.5)

Dual code:

With the activated dual code it is sufficient to enter both codes as alarm codes in order to activate the silent alarm. However, the alarm is activated only if both codes required for opening have been entered completely.

25.5 Lockout period (3 or more incorrect code inputs)

After 3 incorrect inputs the lock switches to a 1-minute lockout period. For each further incorrect code input the lockout period is extended to 2, 4, 8 and finally to 16 minutes. During the entire lockout period no code input is possible. The lockout period can only be omitted by means of the inspection key, however, it cannot be deleted (see chapter 11.1). Only after the lockout period has elapsed, the lock can be opened as described in chapter 10.1 to 10.4.

25.6 Closing the lock

Turn the actuating knob counterclockwise through 90° to the stop . Code input is not required.



If there is a boltwork available (usually recognized due to an additional rotary handle on the secure storage unit), it has to be locked, first, after the door has been closed. Only after that the lock can be closed.

Secure closing of the lock has to be tested by trying to rotate the knob at the input unit. The knob must not be turned through more than approx. 45°.

25.7 Changing codes (P)

Everyone is authorised to change his/her own code any time. The master is not authorised to change the user or courier code. But he/she can activate, block, release and delete codes.

After changing the previous code is no longer valid and the new code must be used. The function of the new code must be tested by opening the lock with the secure storage unit open (see chapter 10.1)!

Description	✓		✗	
1. Press <input type="text" value="P"/> and enter the code to be changed <input type="text" value="I"/> <input type="text" value="D"/> <input type="text" value="X"/> <input type="text" value="X"/> <input type="text" value="X"/> <input type="text" value="X"/> <input type="text" value="X"/> <input type="text" value="X"/> and <input type="text" value="↵"/> (ID [00 to 30 or 95], X = programmed 6-digit combination for the corr. ID number)		2x	3x	3x
2. Enter the new code <input type="text" value="I"/> <input type="text" value="D"/> <input type="text" value="Y"/> <input type="text" value="Y"/> <input type="text" value="Y"/> <input type="text" value="Y"/> <input type="text" value="Y"/> <input type="text" value="Y"/> and <input type="text" value="↵"/> (ID the same as in 2, Y = new 6-digit combination for this ID number)		2x	3x	3x
3. Confirm the new code with <input type="text" value="I"/> <input type="text" value="D"/> <input type="text" value="Y"/> <input type="text" value="Y"/> <input type="text" value="Y"/> <input type="text" value="Y"/> <input type="text" value="Y"/> <input type="text" value="Y"/> and <input type="text" value="↵"/>	2x	2x	3x	3x

Table 54: Changing code



The entire procedure has to be repeated in case of the following errors:

If the Incorrect code signal is displayed according to 1. after the entry of the code to be changed, the code has been entered incorrectly or not assigned and, thus, cannot be changed.

If the Incorrect code signal is displayed after the first new code input as described in 2., the ID does not match the ID in step 1. The ID must always be kept, even in case of code modification.

If the Incorrect code signal is displayed after the second attempt to enter the new code as shown in 3., then the two codes entered in 2. resp. 3 do not match.

25.8 Opening with activated additional functions

The lock has special additional functions (only one of them respectively) which can be set only using the optional PC software. If one of these functions is activated, the lock reacts differently than described above:

- e) Remote disable:
If the "Remote disable" function is activated and there is an active corresponding input signal, each key is acknowledged with 1x 𐀀. Thus, no input is possible.
- f) TD/CW override:
If any time delay times and the associated confirmation windows have been programmed, they can be overridden here.
- g) Dual code override:
This function turns the programmed dual code into a simple code. The second code which is required usually is omitted here.
- h) Omission alarm: If this function is activated at the lock, an separate input signal must be initiated max. 60 seconds before the code input (e.g. by means of a hidden button); otherwise, the lock generates the silent alarm, unlike described in 10.4 in spite of correct code input.

26 Key functions

26.1 Key opening



Opening of the lock using the inspection key is intended only for the emergency situation and not for permanent use. Do not apply force when opening the lock using the key! You could destroy the lock.

For opening by means of the key the rotary handle must be dismantled. Since the rotary handle can be inserted in steps of 90°, first, always note the position of the rotary handle for the assembly later (e.g. using an adhesive tape on the input unit to mark the position of the mark on the rotary handle). Insert the enclosed Allen wrench up to the stop into the small hole on the lateral wall of the input unit (see fig. 5.1) Pull out the rotary handle to the front from the input unit (see fig. 5.2) and remove the Allen wrench. Then pull out the square shaft out of the lock (see fig. 5.3). Now the key can be inserted into the lock as shown in fig. 5.4 (lock housing horizontally with the bolt on the left). If the installation position of the lock is not known, determine the correct direction of the key by testing in 90° steps. Alternatively, you can ask the service technician or the cabinet manufacturer. After correct insertion for lock opening turn the key through approx. 150° to the right to the stop (see fig. 5.5). The lock is open now. After opening by means of the key mount the input unit again in the reverse order as described above and place the key to a safe place, however, do not keep it in the secure storage unit.



Opening by means of the key can also be performed during the lockout period (see 10.5). The key cannot be removed in the Open position of the lock.

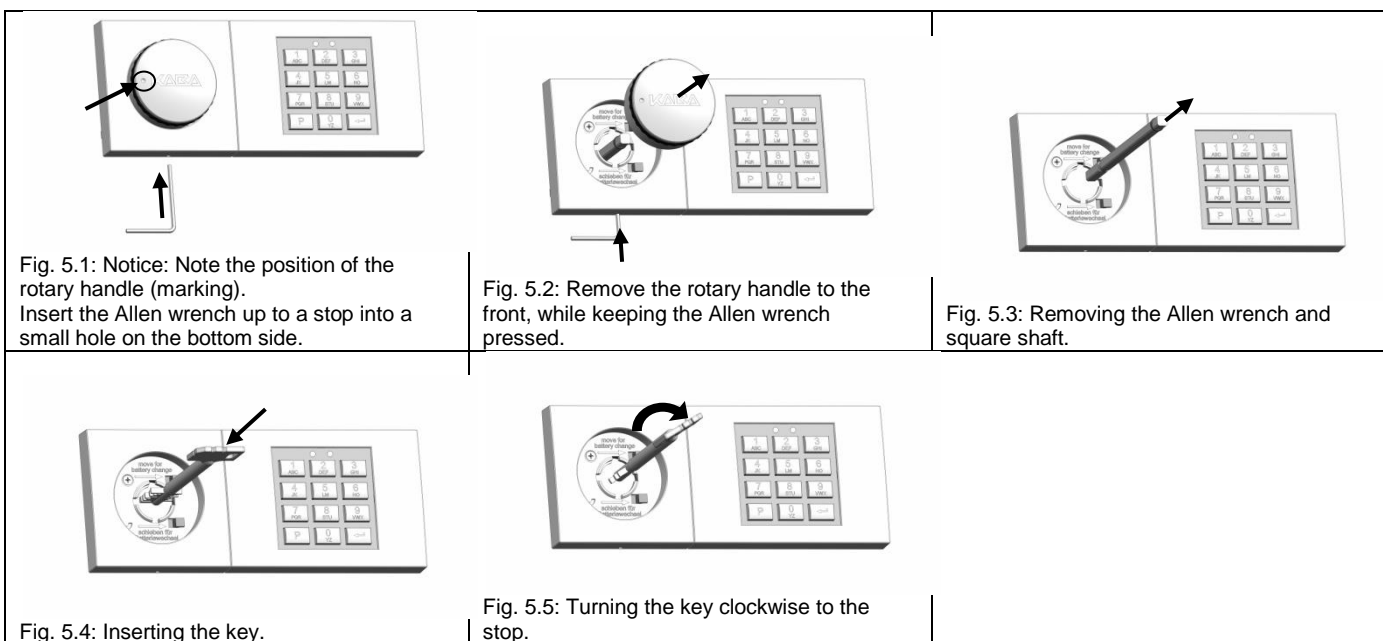

Figure 13: Opening with the key

26.2 Closing using the key

Turn the key to the stop counterclockwise through approx. 150°, remove it and secure against unauthorised access (not inside the secure storage unit). Then insert the square shaft with the end of the bore forwards into the lock (see fig. x) and attach the rotary knob again in the same way as it has been positioned before dismounting (the marking mentioned in 11.1 is designed for this purpose). In case of correct mounting the rotary knob cannot be removed now. The marking can be removed now.

26.3 Changing master code using the key (P)

This programming command is used to change the master code without knowing the master code. This may be helpful if the master code is no longer available, and the other settings of the lock should not be changed.



This programming command can only be executed while the lock is opened using the key. The function of the new master code must be tested by opening the lock with the safe open!

Description	✓		✗	
1. Open the lock using the key (see chapter 11.1)				
2. Press P and		2x	3x	3x
3. Enter the new master code 0 0 X X X X X X and (00 = ID, X = freely selected, 6-digit combination 0..9)		2x	3x	3x
4. Confirm the new master code 0 0 X X X X X X and enter	2x	2x	3x	3x
5. Close the lock using the key again (11.2), mount the rotary handle (11.1) and test the master code with the open safe (10.1 to 10.4)				

Table 55: Changing master code using the key



If both entered codes do not match, the Incorrect code signal is output after the second code input. If the Incorrect code signal is displayed after the first code input, the ID is incorrect. During master code modification the ID must always be "00"!

The procedure can be canceled without change any time by pressing **P** twice. Alternatively, the modification is canceled if there is no input for 30 seconds or if the lock is locked using the key during modification (see chapter 11.2).

26.4 Resetting the lock (P0)

This programming command is used to reset the lock. This means that this procedure deletes all settings of the lock (user code, courier code, dual code, silent alarm, time delay and confirmation window), only the master code and the audit remain unchanged.



This programming command can only be executed while the lock is opened using the key.

Description	✓		✗	
1. Open the lock using the key (see chapter 11.1)				
2. Press P and		2x	3x	3x
3. Press P 0 and	2x	2x	3x	3x
4. Close the lock again by means of the key (11.2) and mount the rotary handle (11.1)				

Table 56: Resetting the lock



This procedure can be canceled any time by pressing **P** twice. Alternatively, the modification is canceled if there is no input for 30 seconds or if the lock is locked using the key before step 3 (see chapter 11.2).

26.5 Reconfiguration of the lock after opening by means of the key using software

For further details on the procedure refer to the operating instructions for the PC software.



After opening the lock using the key according to 11.1 and connecting it to the PC software a complete reconfiguration of the lock is possible, namely without knowing or changing the master code. Only an audit entry is performed.

27 Further special functions

27.1 Connection to the PC software

The lock has an additional mini-USB interface on the input unit. The lock can be programmed via this interface using the PC software available as an accessory.

The following functions are available when using the additional PC software:

- c) Reading out audit
- d) Programming the lock settings using software

For further details on this refer to the operating instructions of the PC software.

27.2 Additional functions via the signal input

The lock has an option which allows implementing one of the additional functions via the signal input according to 10.8. The assignment of the signal inputs is described in the installation manual of the lock. The functions can only be activated with the optional PC software. The operating behaviour of the lock with different input signals active is described in 10.8.10.8.

27.3 Additional functions via the signal outputs

The lock has 2 signal outputs: Details on assignment of the outputs are given in the installation manual. The following outputs are available:

- c) Silent alarm. For details on programming refer to chapter 9.5, on operation refer to chapter 10.4,
- d) Microswitch for bolt monitoring, no additional programming possible.

28 Power supply

Two batteries of type AAA are available in the input unit for power supply of the lock. It is highly recommended to replace them every 2 years (see chapter 0), irrespectively of how often the lock has been used.

28.1 Low battery

If the operator receives the undervoltage signal (10x ) after the code entry, then the battery capacity is low and the battery must be replaced promptly (see chapter 13.2).

 As soon as the low battery is displayed, the lock can still be opened, but no reprogramming is possible until after the battery replacement. Furthermore, an audit entry is performed. As soon as the battery is almost completely exhausted, no opening can be performed and every key stroke is acknowledged with an undervoltage signal.

28.2 Battery replacement

 Do not apply force and avoid touching electronic components! You could destroy the lock.

For battery replacement the rotary handle of the lock must be dismantled. Since the rotary handle can be inserted in steps of 90°, first, always note the position of the rotary handle for the assembly later (e.g. using an adhesive tape on the input unit to mark the position of the mark on the rotary handle). Insert the enclosed Allen wrench up to the stop into the hole on the lateral wall of the input unit as shown in Fig. 6.1. Pull out the rotary handle to the front from the input unit (see fig. 6.2) and remove the Allen wrench. Then unscrew the screw in the handle recess (see fig. 6.3). After that the top part of the input unit can be moved as shown in fig. 6.4 and then it can be removed to the front (see fig. 6.5). The 2 batteries are located on the base part of the input unit and can be replaced now as shown in fig. 6.6. Only batteries of type AAA can be used. It is highly recommended to use high-quality brand batteries and replace them as a precaution every 24 months at the latest. After the battery replacement mount the input unit on the base part from the front in the order reverse to the one described above and move it laterally until it engages and the red LED turns off. Then attach the screw to secure the top part. Now attach the rotary handle in the position in which it has been mounted before dismantling (to do so, use the marking mentioned above). If the mounting is correct, the rotary handle can no longer be removed. Remove the marking (in this way). Finally, the tamper switch message must be neutralised (see chapter 9.6). It can be performed only by the master.

Finally, the tamper switch message must be neutralised (see chapter 9.6). It can be performed only by the master.

Battery replacement (example above: the input unit keyboard is located to the right of the rotary handle. For other mounting positions proceed correspondingly):

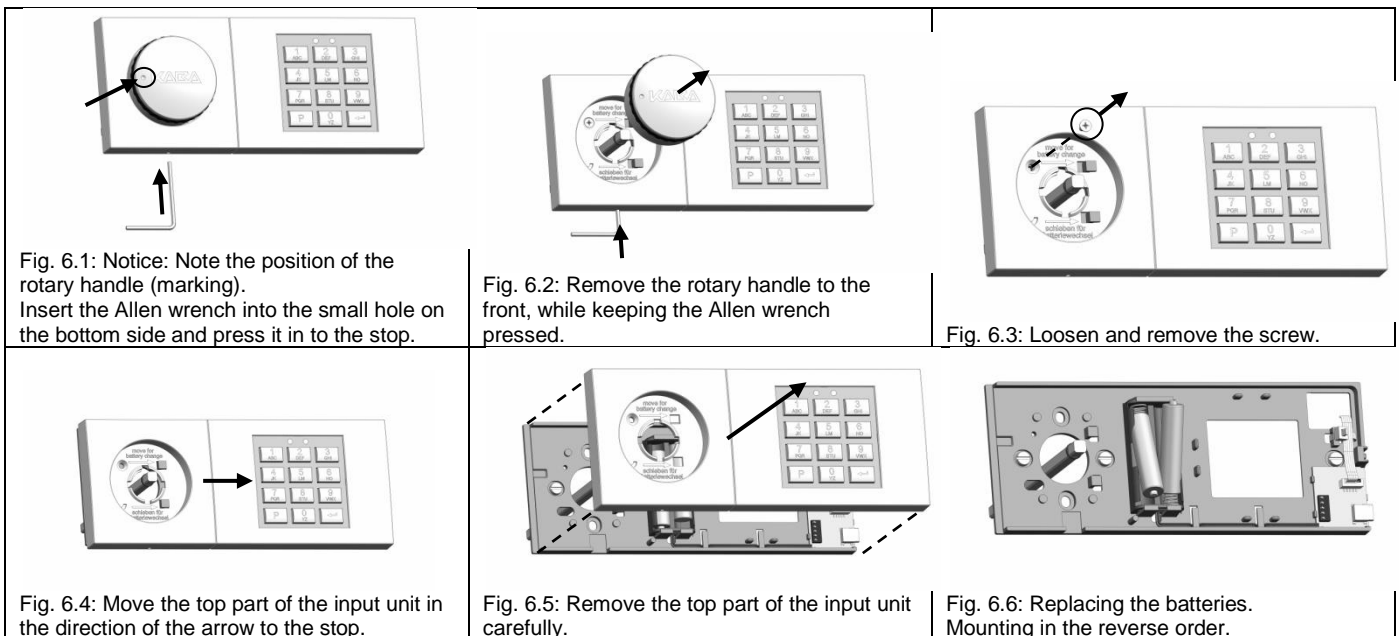

Figure 14: Battery replacement

28.3 Permanent power supply

If necessary, along with the battery power supply the lock can also be supplied with voltage permanently. The following options are available for this purpose:

- a) Power supply via the intruder detection system and the alarm box (art. no. 3001001550)
- b) Power supply via the alarm box (see above) for connection to the signalling equipment without power supply option via the additional 12V power supply unit at the alarm box (see above) art. no. 3002501230
- c) If the lock is used without any signalling equipment: 9V power supply unit can be connected directly at the lock, art. no. 3002501220



Even with the permanent power supply the batteries must still be inserted into the input unit because otherwise the lock cannot be opened by means of the code entry in case of power failure or a fault of the permanent power supply. The low battery is displayed in case of the permanent power supply failure and exhausted battery (see chapter 13.1). The batteries and the permanent power supply should be checked as soon as possible in this case.

29 Service

In case of faults or service tasks described in this manual it is highly recommended to consult a professional service technician or the safe manufacturer.

The lock has a label with the production data on the input unit, these data that might be helpful, for example in case of the first telephone consultation or in case of service for the initial fault localization. If you would like to access these data, open the input unit similarly as for the battery replacement described in chapter 13.2.

The label is clearly visible on the inside of the top part of the input unit:



Figure 15: Label with the production data in the input unit

The label contains the following information:

	Type:	CB30	← Lock type
	Part No.:	98060/0001	← Article number of the input unit
	Serial No.:	26000113031005	← Serial number of the input unit
	Version:	CB30 IU V1.0 2013	← Version number of the firmware and year of manufacture

Figure 16: Information on the label

30 Notes

Kundendienst

CLAVIS Deutschland GmbH
Schillerstraße 47-51
34117 Kassel

Telefon: +49 (0)561 988 499-0
Fax: +49 (0)561 988 499-99
E-Mail: info@tresore.eu
Internet: www.tresore.eu
www.tresorschloss.de